

CreatBot D600 Pro 2

User manual

English V1

CONTENTS

Notice	3
Machine Diagram	
Front.....	4
New Printer Head	5
Printer Operation	
Leveling Platform.....	7
Load Filament	8
Unload Filament.....	9
Main menu.....	10
Detail page.....	12
Axis operation.....	13
Filament menu.....	14
SD Card/U-disk.....	15
Info. menu.....	16
Setting menu	17
Frequently Asked Questions	
Change Fuse.....	20
Hardware Troubleshoot.....	21
Printing Troubleshoot	22

Icon conventions



Tip icon to remind users to have a good method or technique.



Note icon, to remind the user must be given adequate attention.



Prohibition icons, prevents users from unauthorized operation.

Notice

Read First

Thank you for choosing CreatBot 3D printer!

This manual contains important information about the installation, use, maintenance and common problems of CreatBot 3D printer. Please read this manual carefully before using 3D printer. All losses caused by the breach of the notes and the operation process of the operation process will be borne by the user. Please use the filament provided by CreatBot, or high quality filament by third manufacturers. Due to the use of third party inferior material caused by the failure of the printer, the loss will be borne by the user.

Software running environment, 2G or above processors, at least 1G memory, compatible with Windows, MAC, or Linux, please use memory as much as possible.

I wish you have fun with CreatBot 3D printer!

Danger Warning



The nozzle's temperature will reach 420 degrees, don't touch.



The platform's temperature will reach 100 degrees, don't touch.



Please make sure that the printer connected to the ground.



Do not attempt to open the case, be careful of electric shock.

Working Environment



The 3D printer can work in the indoor environment of 5 °C to 30 °C.



Long-term not use of the printer, be sure to keep off dust, moisture.



Long-term not use of the filament, please be sealed to prevent deterioration.

Machine Diagram

Front



Machine Diagram

Print Head



1. PCB box
2. Filament press button
3. Feeding tube
4. Connector
5. Servo

6. Extruder box
7. Cooling fan

Machine Diagram

Extruder

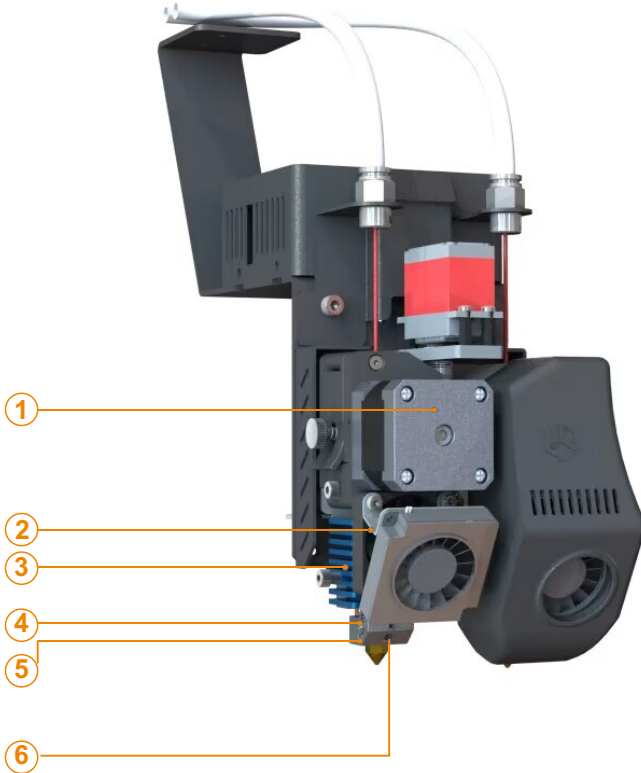

- 1. Extruder motor
- 2. Sink fan
- 3. Heat sink

- 4. Heating tube
- 5. Heating sensor
- 6. Hotend

Printer Operation

Leveling Platform

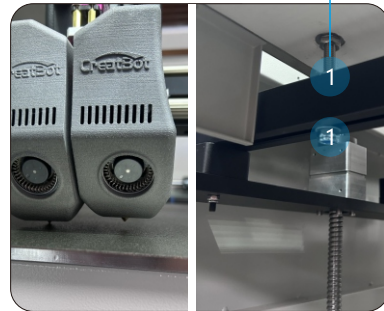
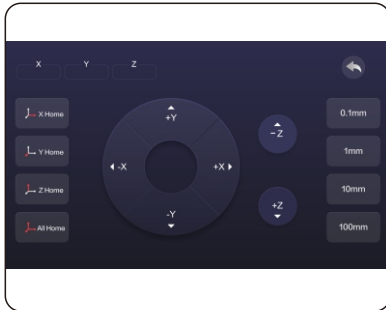

1. Turn on the printer.
2. On the touch screen, press "Move axis" -> "All home".Then "-Z" —> 100mm. Till "Z" is at 0.00mm.
3. Move the extruder by hand to 4 corners of bed, check the distance between nozzle and bed. Tighten or loosen 4 adjusting nuts below the bed to make sure the distance between nozzle and bed is around 0.20mm with your feeler blade or approximately the thickness of one business card in all corners to ensure the bed is levelled.
4. Repeat "All home" like in step 2. Now "-Z"—>100mm till "Z" is at 0.00mm again. Now focus on the distance between the Extruder Nozzle and Print Bed. It needs to be 0.10mm or just slightly under. If the distance is too big "example you can fit a 0.10mm feeler blade or business card in, decrease the setting Servo Z offset value in -0.10mm steps and recheck the distance with your feeler blade. If adjusted the wrong way the nozzle will become too close to the bed, so increase the Servo Z offset value in +0.10mm steps each time and recheck the distance with your 0.10mm feeler blade.
5. Auto Level Process. Enter "Setting"-> "Auto leveling" and press -> "Probe". Machine will start to detect 25 points. Once the Probe is COMPLETED, press SAVE.

Printer Operation

Load Filament

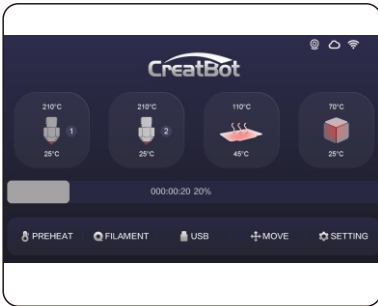

Preheat head

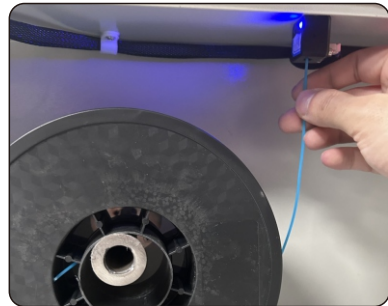

Straightened filament

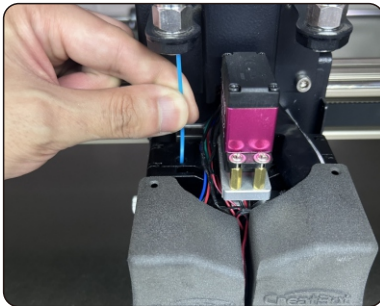

Load filament

1. Preheat the hotend before loading filament.
2. Straightened filament and check the filament do not self-winding.
3. Thread the filament through the filament detection device and manually load the filament until it exits the feed tube above the extruder.
4. Insert the filament into the gear of the extruder and click Load. Until the filament come out from the nozzle.
5. Click Done.



Notice: Pressed filament too tight or too loose will affect normal wire feeding.

Printer Operation

Unload/Change Filament

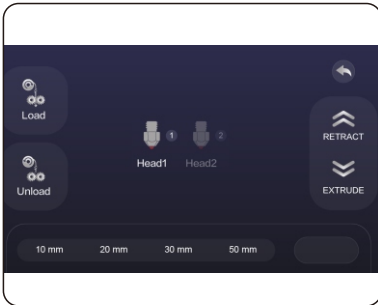

Unload filament menu

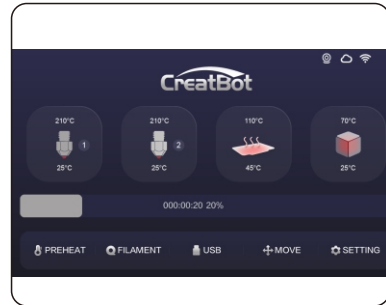

Preheat head

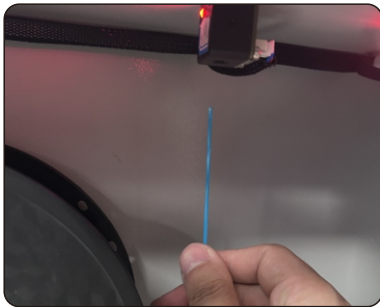

Pull out filament





1. Enter "Filament" menu -> "Unload filament", and select the head you want unload.
2. Wait for the nozzle heated to a suitable temperature.
3. After reaching temperature, feeder will send a certain number of filament, and then automatically withdraw filament.
4. To manually unload filament, same as above mentioned.

Printer Operation

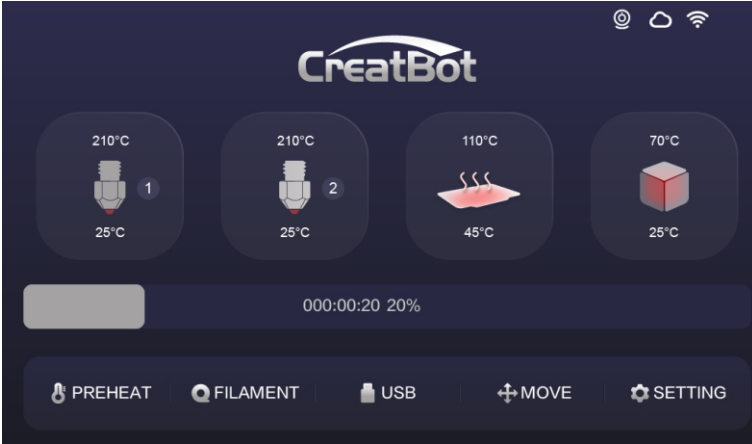
Touch screen

Main Menu





 <p>210°C 25°C</p>	<p>Touch and set up the temp of the nozzle.</p> <p>210°C Preset nozzle temperature 25°C Current nozzle temperature</p>
 <p>210°C 25°C</p>	<p>Touch and set up the temp of the nozzle.</p> <p>210°C Preset nozzle temperature 25°C Current nozzle temperature</p>
 <p>110°C 45°C</p>	<p>Touch and set up the temp of the hotbed.</p> <p>110°C Preset platform temperature 45°C Current platform temperature</p>
 <p>70°C 25°C</p>	<p>Touch and set up the temp of the Chamber.</p> <p>70°C Preset Chamber temperature 25°C Current Chamber temperature</p>

Printer Operation

Touch screen

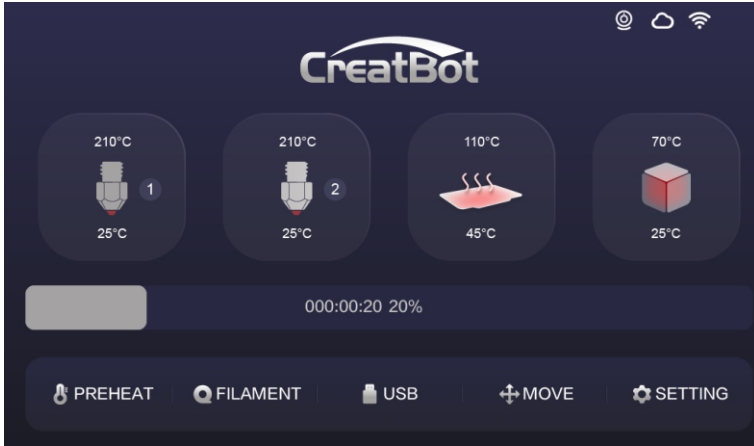
Main Menu





	preheat		Open U-disk
	Cool down		USB unavailable
	Filament menu		bed up
	Move axis		bed down
	resume		stop
	Setting		pause

Printer Operation

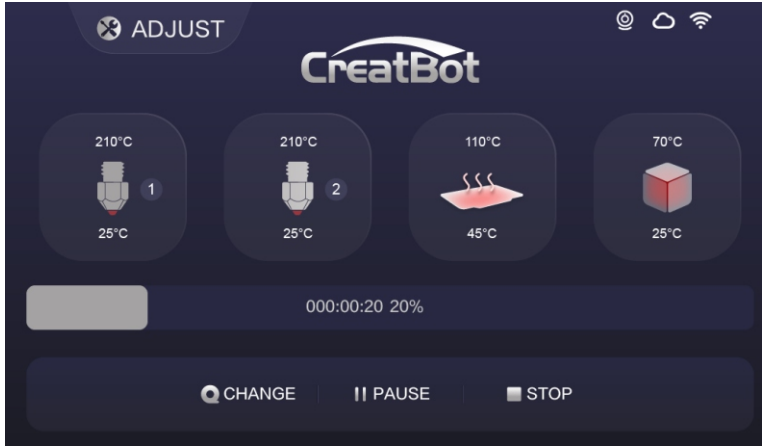

Touch screen

Detail page



 Adjust. During printing, you can click it to adjust the print speed and the extrusion.

Current printing progress

 change  pause  stop

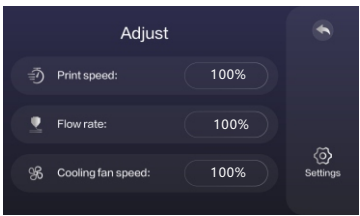



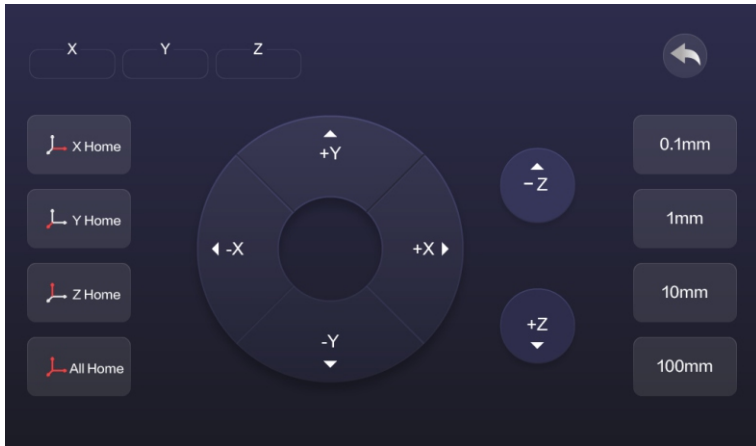

print speed: 100%
 flow rate: 100%
 colling fan speed: 100%

Printer Operation

Axis operation







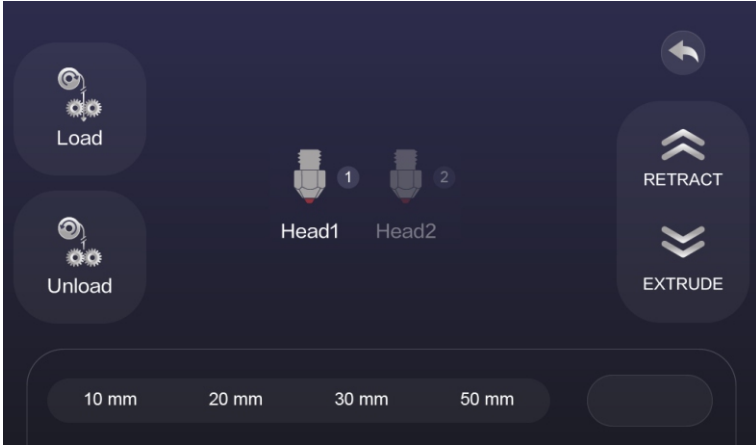

	Move X to home	0.1mm	Minimum units
	Move Y to home	1mm	
	Move Z to home	10mm	
	All axis to home	100mm	

	Move Y axis		Move X axis		Z down/up
	Back				
<input type="text" value="X"/>	<input type="text" value="Y"/>	<input type="text" value="Z"/>	X,Y,Z current position of hotend.		

Printer Operation

Filament menu



 1  2	#1 extruder(unavailable) #2 extruder
 	Extrude filament / Retract filament
	Back
	Click and enter a value



Load



Unload

load/unload





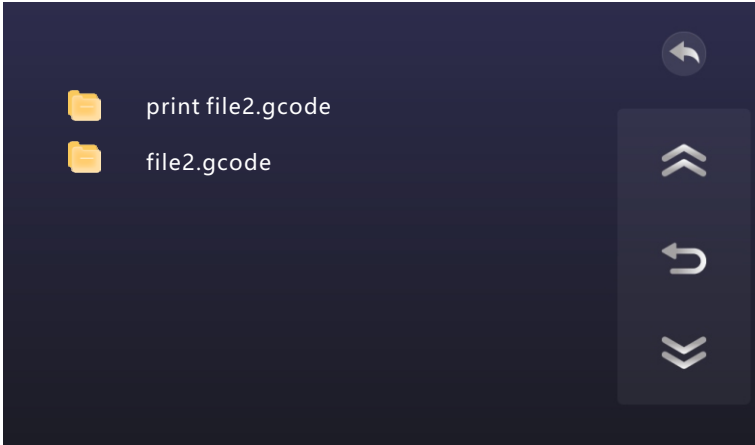

Adjust value when extrude/retract filament

Printer Operation

SD Card/U-disk



	Click and choose a file to print
	Last page
	Superior menu
	Next page
	Back



Printer Operation

Info. page



Time used 0000:00:00	Print time used
Firmware 6.1.XXXXXX	Firmware version
UI version 6.1.0	UI version
	Back

Printer Operation

Setting menu

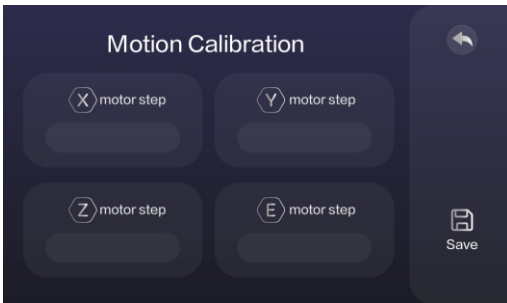
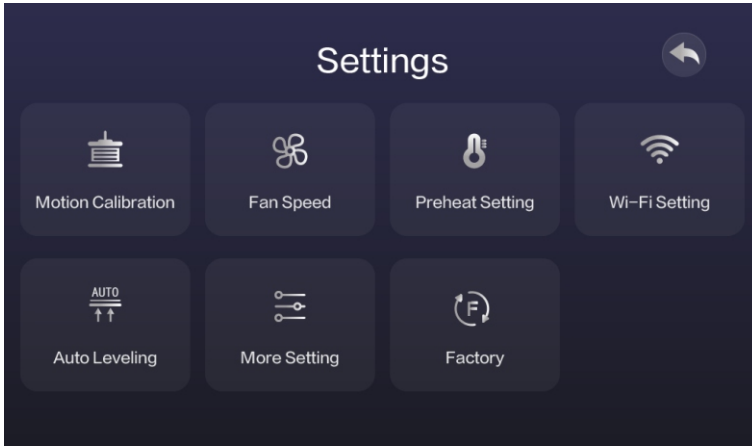

X/Y/Z and extruder motor setting (range:5-9999)



The values in the picture are not real values, the real values refer to the printer default values



Printer Operation

Setting menu

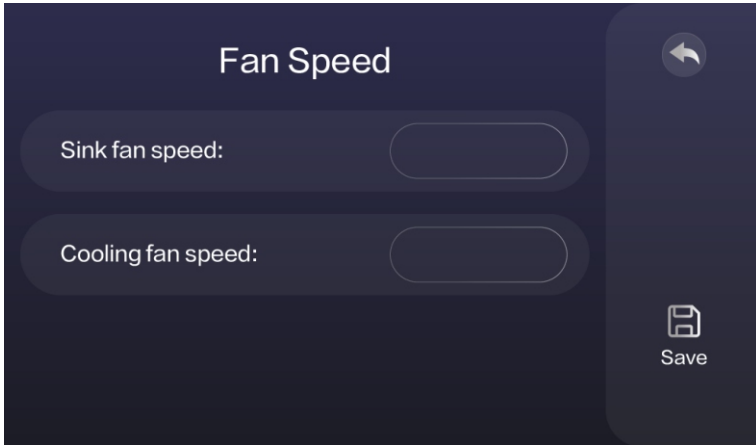

sink fan speed (range:1-100)
cooling fan speed (range:1-100)

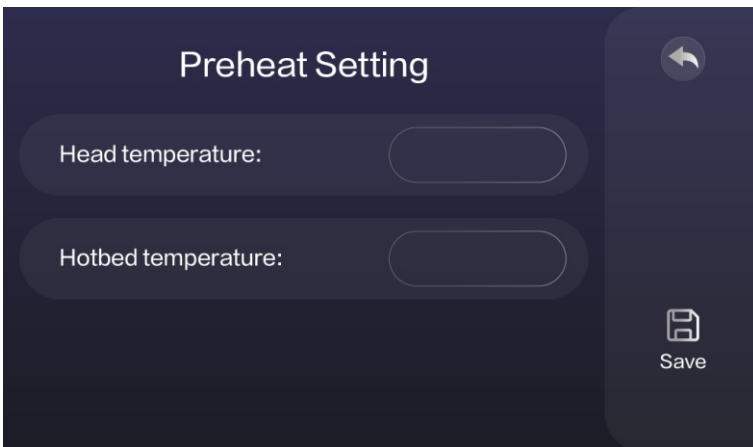

head temperature (range:0-420)
hotbed temperature (range:0-100)

Printer Operation

Setting menu

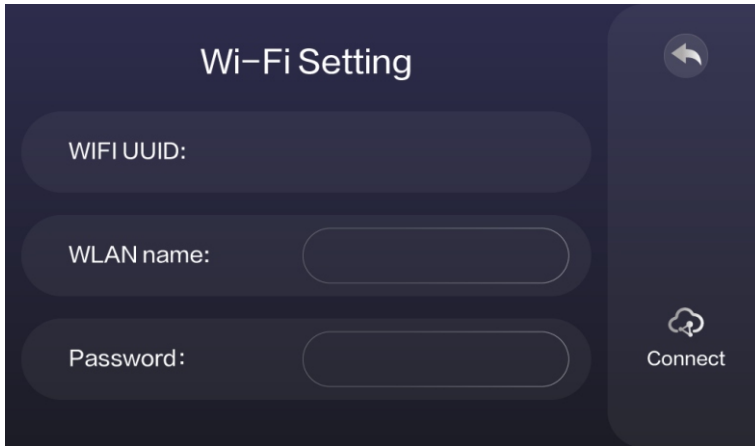

The image shows a dark-themed 'Wi-Fi Setting' screen. At the top, the title 'Wi-Fi Setting' is centered. Below it, there are three input fields: 'WIFI UUID:', 'WLAN name:', and 'Password:'. Each field has a corresponding rounded rectangular input box. On the right side of the screen, there is a back arrow icon at the top and a 'Connect' button with a Wi-Fi icon below it.

Enter the WiFi name and password, and click Connect. The printer will automatically connect to WiFi.

Only supports 2.4GHz Wi-Fi.

Frequently Asked Questions

Change Fuse



Open fuse tray



Change new fuse

Frequently Asked Questions

Hardware Troubleshoot

1. Display "MINTEMP" ?

The environment is too low, or temperature sensor is damaged, please keep the room temperature above 0°C.

2. Display "MAXTEMP" ?

Temperature of nozzle or bed too high, or temperature sensor is damaged, please keep their temperature in a suitable range.

3. USB connection problems ?

Please specify the correct port and baud rate (250000), or change a shorter USB cable.

4. Nozzle heats up too slowly ?

Temperature in door is too low, or use a fan duct, or turn up output voltage (24.5v).

5. Print head stuck ?

Clean the guide rail and add lubricating oil.

6. Print head can not move ?

Stepper motor chipset burned, or belt damaged, or belt wheel screw loose.

7. Print head hit the framework ?

Corresponding axis stop limit or circuit fault.

8. Unable to power on ?

Power switch is damaged or fuse is burned, and please check whether the power adapter is working properly or power check board is damaged.

Printing Troubleshoot

1. How to set the temperature of the nozzle ?

Different filament temperature is different, general as follows:

PLA temperature 190°C ~210°C, bed 45-60°C.

ABS temperature 230°C ~250°C, bed 80-100°C.

You must leave enough time for filament heating, so the faster printing speed need the higher temperature, 60mm/s temperature need raise about 10°C. In the same way, larger thickness need higher temperature.

2. How to set the temperature of the hot bed ?

The main purpose of the hot bed is to prevent model wrapped, PLA need about 45°C and 70°C for ABS is enough, but due to the environment and filament, we often need to increase the temperature, the highest temperature not over 120°C, and you can close the bed above 100mm.

Printing Troubleshoot

not over 120°C, and you can close the bed above 100mm except printing ABS or other high-temperature required filaments.

3. The model not stick on the platform ?

Please paste masking paper or Kapton tape on the platform, or the nozzle is too far away from the platform, or the bottom of the model is not flat.

4. No or less silk coming on the first layer ?

The distance between nozzle and platform is too small, or the filament has not been sent to the nozzle.

5. Why nozzle is not spit silk ?

The filament is not pressed or too tight, or print temperature is too low, or the filament feeder not working.

6. How to prevent model become warped ?

Increase hot bed temperature or use Kapton, or change platform adhesion type to Raft, or cover the baffle, or reduce indoor ventilation.

7. How far from nozzle to platform appropriate ?

Distance should be 0 in theory, but there is no absolutely flat platform, so the distance should ± 0.1 mm. Finally, with the actual printing effect as the standard, too close will lead to a silk blocked, too far will cause the model not stick on the platform.

8. How to determine whether the temperature is too high ?

PLA temperature is too high will appear liquefaction, ABS will be the carbide, that will block the nozzle.

9. What reasons will causing nozzle blocked ?

Filament are impurities or print environment dust too much, bad of thermal conductivity between the nozzle and the heating block.

10. Model surface is loose with crack ?

The layer is too high or the printing speed too fast, nozzle temperature too low or filament press nut too loose, or filament is wrapped.

11. How to print a small model ?

Multiple the model, and print them at a time.

12. Dual color model not aligned ?

Adjust offset of second nozzle in machine settings.

13. Dual color model color interference ?

Align two nozzle in vertical direction

14. There is too much silk drag on the model ?

Please enable filament retraction, and specified proper retract speed, and distance, the retract distance should not less than 4mm, and the speed not less than 10mm/s.



Quality · Experience · Service

Henan Creatbot Technology Limited

Telephone: +86 4000-558-930

Website: www.CreatBot.com

Email: sales@creatbot.com

Address: 6#, Chaoya Industry Park,
Hanghai Road, No.13 Ave.,
Eco-Tech Development Zone,
Zhengzhou City, Henan Province, China